

FLOYD • FLOYD 120 DEEP divano/sofa/canapé/sofa
elementi/elements/éléments/elemente



Struttura portante: Multistrato, legno massello.

Imbottiture: Schienale in piuma d'oca. Seduta in piuma d'oca con inserto in poliuretano espanso a densità differenziata (35-30 Kg/mc). Scocca in poliuretano espanso a densità differenziata rivestito in resinato 100 g accoppiato con vellutino.

Molle: Cinghie elastiche in polipropilene e gomma.

Main structure: Solid wood.

Upholstery: Backrest in goose feathers. Seat in goose feathers with internal padding in polyurethane foam with different densities (35-30 Kg/mc). Chassis in polyurethane foam with different densities covered with resinato 100 g and elastic velvet.

Suspensions: Elastic belts in polypropylene and rubber.

Structure: Multiplis et bois massif.

Rembourrage: Dossier en plume d'oie. Assise en plume d'oie avec insert en mousse de polyuréthane en plusieurs densités (35-30 Kg/mc). Chassis en mousse de polyuréthane avec plusieurs densités recouvert avec resiné 100 g couplé avec velour.

Suspension: Sangles élastiques en polypropylène et mousse.

Struktur: Vielschichtiges Massivholz.

Polsterung: Rückenlehne aus Gänsedaunen. Sitz aus Gänsedaunen mit Einsatz aus Polyurethanschäum in unterschiedlichen Dichten (35-30 Kg/mc). Chassis aus Polyurethanschäum in unterschiedlichen Dichten beschichtet mit Resinat 100 g Samt gekoppeltem.

Federung: Elastische Gurte aus Gummi und Polypropylen.

Cod. Tessuto/fabric/tissu/Stoff: 01/1
Cod. Pelle/leather/cuir/Leder: 02/2

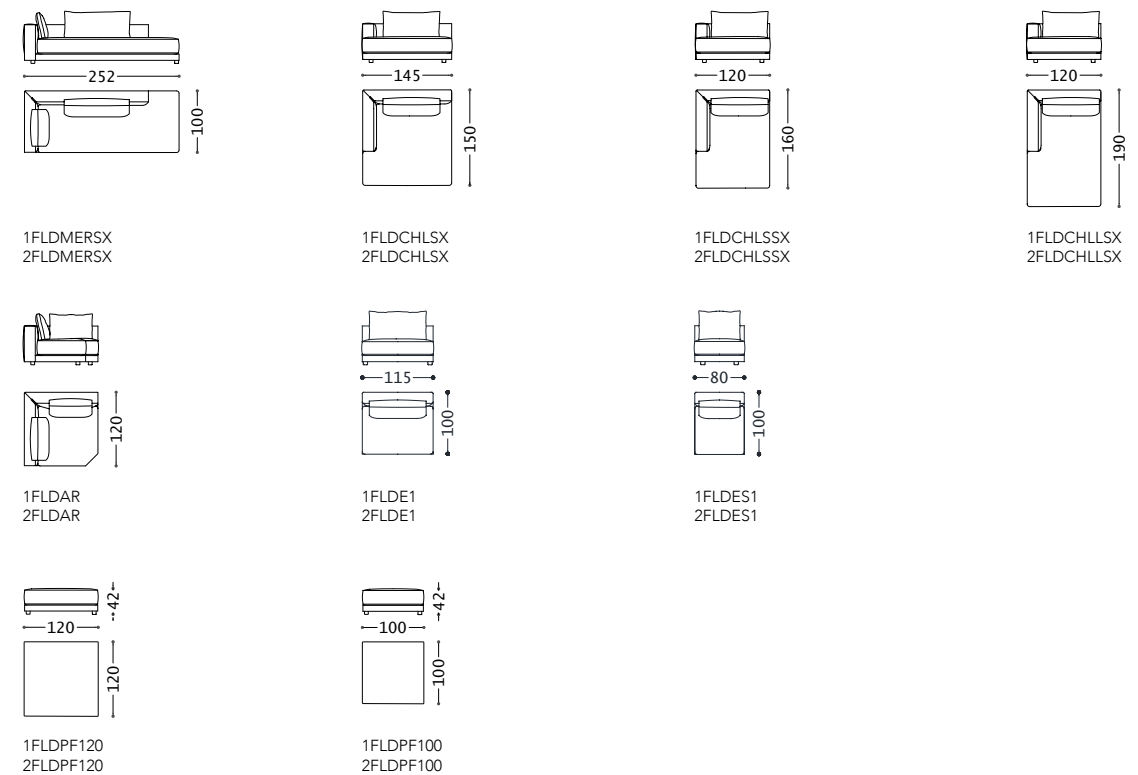
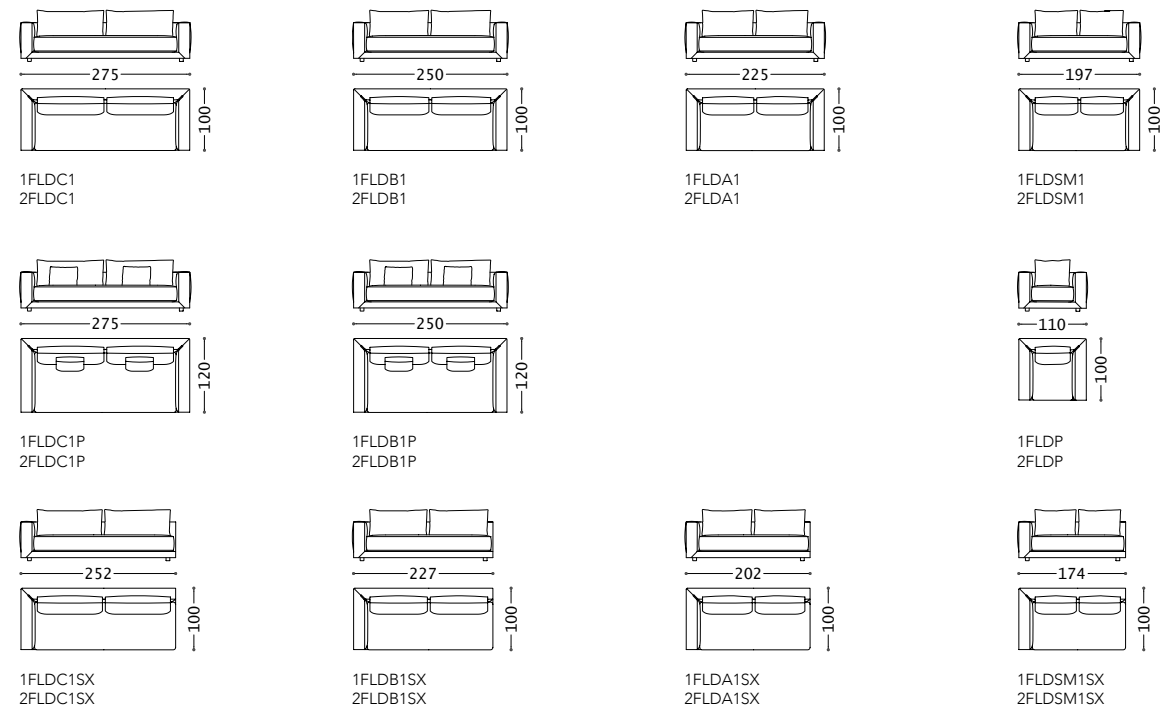
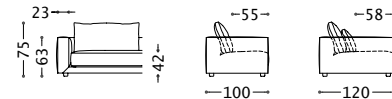

FLOYD • FLOYD 120 DEEP divano/sofa/canapé/sofa
composizioni/compositions/compositions/Kompositionen

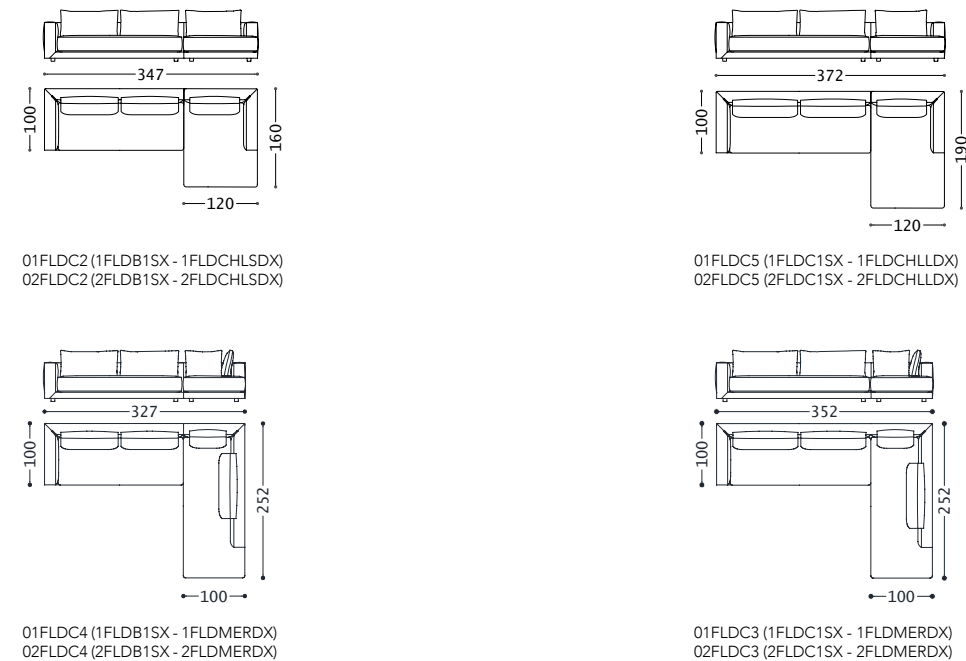

FLOYD • FLOYD 120 DEEP divano/sofa/canapé/sofa
 elementi con tavolino/elements with small table/éléments avec table/Elemente mit Couchtisch

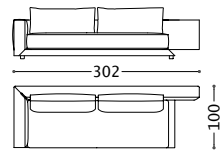

1FLDESPSX
2FLDESPSX

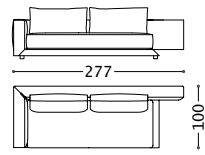

1FLDESPMSX
2FLDESPMSX

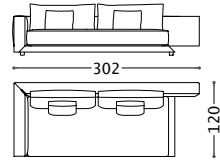

1FLDESPRSX
2FLDESPRSX

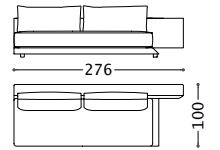

1FLDESP1TDX
2FLDESP1TDX

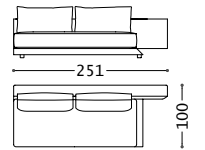

1FLDESPM1TDX
2FLDESPM1TDX

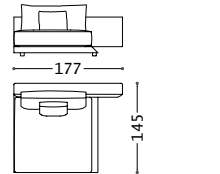

1FLDCHLC1TDX
2FLDCHLC1TDX

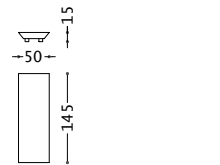

1FLTTAVCM
1FLTTAVCML

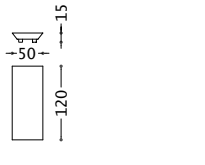

1FLTTAVTP
1FLTTAVTPL

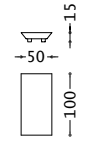

1FLTTAVTS
1FLTTAVTSL

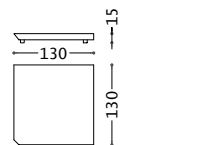

1FLTTAVAPDXSX
1FLTAVAPDXSXL

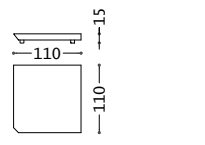

1FLTTAVADXSX
1FLTAVADXSXL

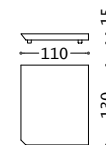

1FLTTAVAPDX*
1FLTAVAPDXL*

FLOYD • FLOYD 120 DEEP divano/sofa/canapé/sofa
 composizioni con tavolino/compositions with small table/compositions avec table/Kompositionen mit Couchtisch

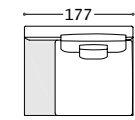

1FLTTAVCM + 1FLDCHLC1TSX
1FLTTAVCM + 2FLDCHLC1TSX
1FLTTAVCML + 1FLDCHLC1TSX
1FLTTAVCML + 2FLDCHLC1TSX

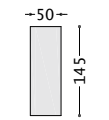

1FLTTAVCM
1FLTTAVCML

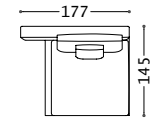

1FLDCHLC1TSX
2FLDCHLC1TSX

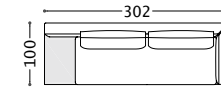

1FLTTAVTS + 1FLDESPDX
1FLTTAVTS + 2FLDESPDX
1FLTTAVTSL + 1FLDESPDX
1FLTTAVTSL + 2FLDESPDX

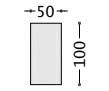

1FLTTAVTS
1FLTTAVTSL

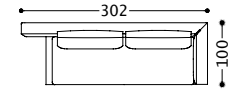

1FLDESPDX
2FLDESPDX

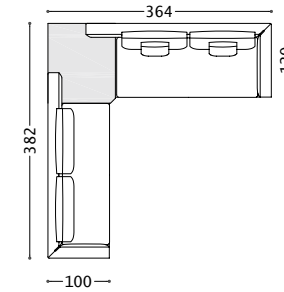

1FLDESPSX - 1FLTTAVAPSX - 1FLDESPPRDX
2FLDESPSX - 1FLTTAVAPSX - 2FLDESPPRDX
1FLDESPSX - 1FLTAVAPXSXL - 1FLDESPPRDX
2FLDESPSX - 1FLTAVAPXSXL - 2FLDESPPRDX

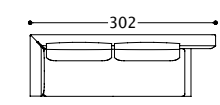

1FLDESPSX
2FLDESPSX

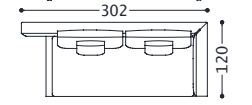

1FLDESPPRDX
2FLDESPPRDX

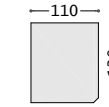

1FLTTAVAPSX
1FLTAVAPXSXL

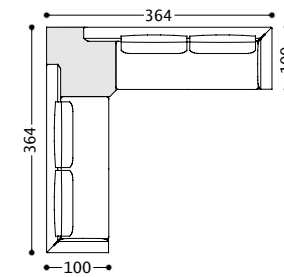

1FLDESPSX - 1FLTTAVADXSX - 1FLDESPDX
2FLDESPSX - 1FLTTAVADXSX - 2FLDESPDX
1FLDESPSX - 1FLTAVADXSXL - 1FLDESPDX
2FLDESPSX - 1FLTAVADXSXL - 2FLDESPDX

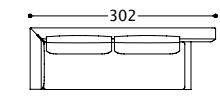

1FLDESPSX
2FLDESPSX

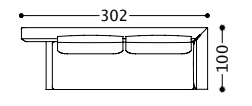

1FLDESPDX
2FLDESPDX

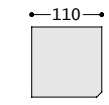

1FLTTAVADXSX
1FLTAVADXSXL

*Il verso del tavolo destro e sinistro a profondità differenziata viene determinato dal lato nel quale si aggiunge l'elemento a profondità standard (100cm)
 The right/left orientation of the small table with a different depth is determined by the side on which the standard element (d.100 cms) hangs up.